



BAMBOO COMMENT BOSS®

Congratulations on the purchase of your Mail Boss® Bamboo Comment Boss. On this insert you will find a list of hardware parts included as well as detailed instructions. Installation is quite simple and requires only a #2 Phillips Head screwdriver. Installation will be most easily accomplished if you take the time to carefully sort the hardware and familiarize yourself with the function of each piece.

If you require assistance with assembly or part replacement, or for any other matter, contact the toll-free Epoch Design Service Center from anywhere in the Continental United States, Monday through Friday, 9AM - 5PM Pacific Standard Time at 1-800-589-7990. You may also email your request or comments to info@mailboss.com and a service representative will respond. You can also find helpful hints and tips on our website: www.mailboss.com/resources/

Thank you.

Parts and Hardware List

- 3** 1 3/4" Phillips head screws
Used to connect the Comment Boss to a wall or platform

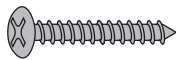

- 2** Security keys
Used to lock and unlock your Comment Boss



- 1** Comment Boss® box
Locking security suggestion box

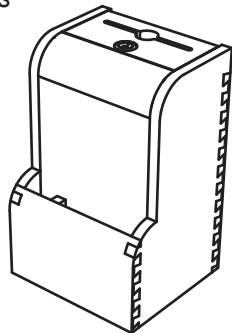

- 2** Wall anchors
Used when installing into drywall

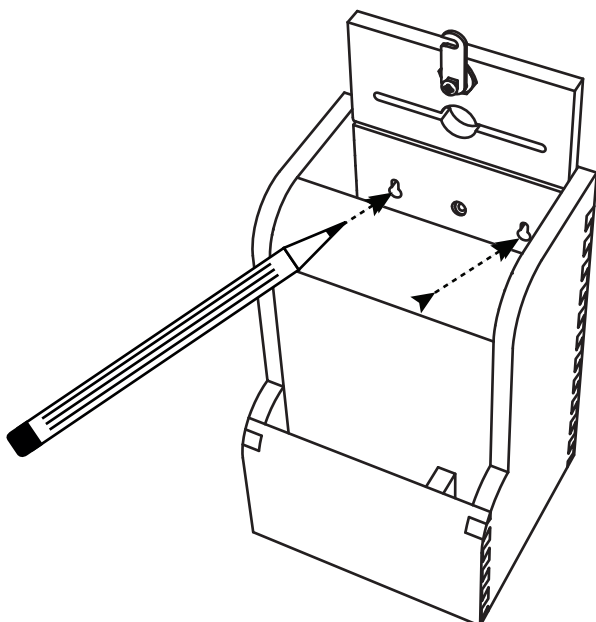

- 1** If you're mounting your comment box on a wall simply hold your box in its desired position and mark the location of the mounting holes using a pencil. The use of a level is encouraged but not required.

If your wall surface is drywall, drill two 5/16" holes in the marked locations and insert the wall anchors.

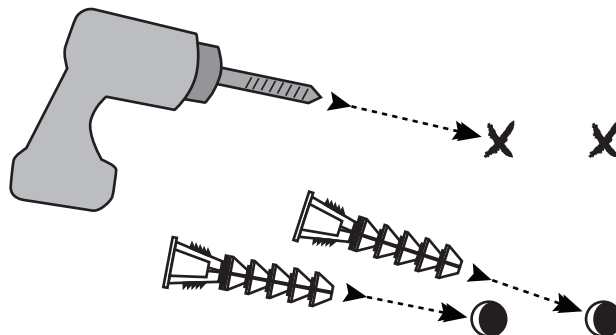

Have a question?... Need a part ASAP?...1-800-589-7990



MAIL BOSS
LOCKING SECURITY MAILBOXES



2 Insert screws into the two outer mounting holes and leave the screws protruding about 1/2" from the mounting surface.

3 Install the box to the surface by sliding it onto the two screws then down slightly.
Then Secure it into place using one center screw at a steep angle.

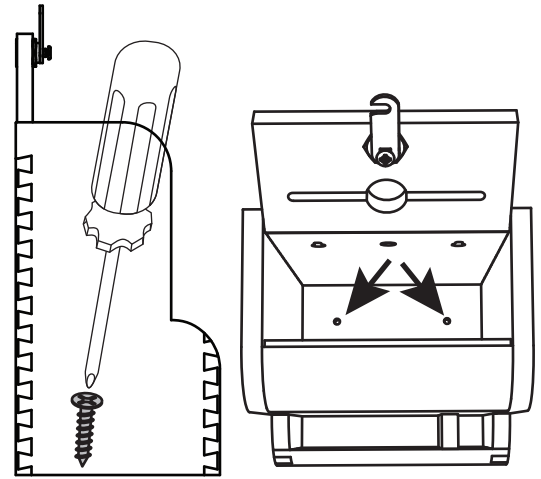
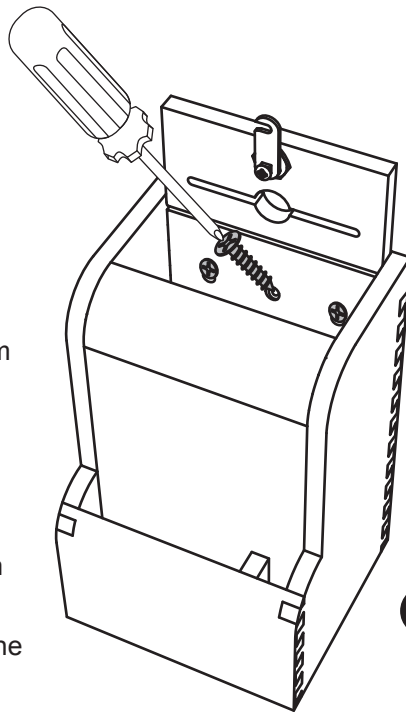

4 For surface mount, simply secure into place using the screws provided in the holes in the bottom of the box.

MAIL BOSS[®]

Accessory items and parts available:
www.mailboss.com



Dropbox
Available In All Colors

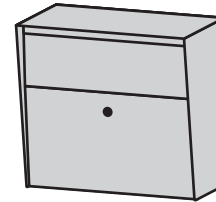

Metro
Available In All Colors

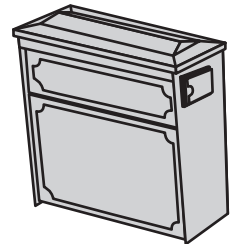

Townhouse
Available In All Colors

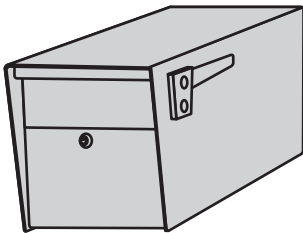

Mail Manager
Available In All Colors

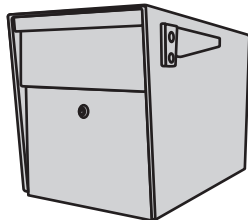

Mail Boss
Available In All Colors

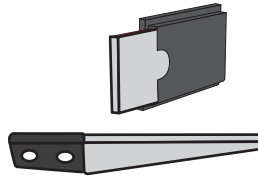

Flags



HASP Lock
Padlock Compatible

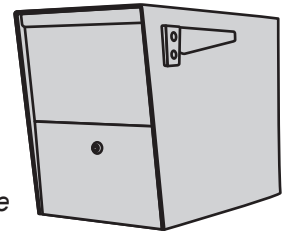

Package Master
Available In All Colors

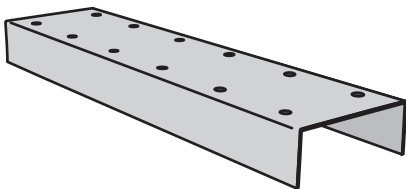

Spreaders Bars
Allows Mounting Of Two, Three Or Four Mailboxes On One Post
Available In All Colors

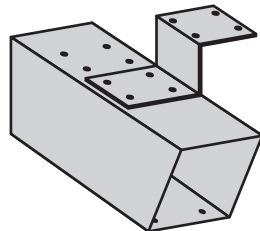

Newspaper Holders
Available In All Colors

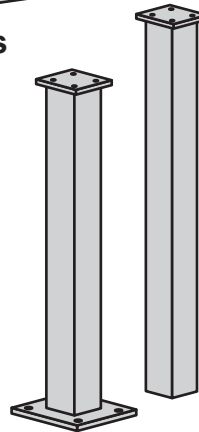

Mounting Posts
Available In All Colors



Lock Dust Cover
Protects Lock Mechanism

Have a question?... Need a part ASAP?...1-800-589-7990